

Stability Issues in the PSB

A historic overview...

F. Pedersen, CERN/AB/RF



Outline

- Longitudinal Instabilities
 - Longitudinal beam dynamics in PSB
 - Effects of space charge
 - Coupled bunch modes
 - Adding second harmonic RF
 - Stability of depleted (hollow) distributions
 - Stability of fundamental RF mode and loops
 - Microwave instabilities
- Transverse Instabilities
 - Driving impedance
 - Transverse damper

Longitudinal Space Charge



- i. Cancels Landau damping above a well defined threshold for single harmonic RF system
- ii. Reduces bucket area significantly with increasing intensity
 - Verified in detail (experimentally and theoretically) during in 1977 ($h=5$ era): $2 \cdot 10^{12}$ protons per ring for the dipole mode ($m = 1$) and above $3 \cdot 10^{12}$ protons per ring for the quadrupole mode ($m = 2$)
 - For *same relative bucket filling*, this threshold scales as V_{rf}/h , so it has **gone up a factor 3.3** with the $h = 1$ conversion in 1998: $V_{rf} = 12 \rightarrow 8$ kV, $h = 5 \rightarrow 1$

Space Charge and Landau damping

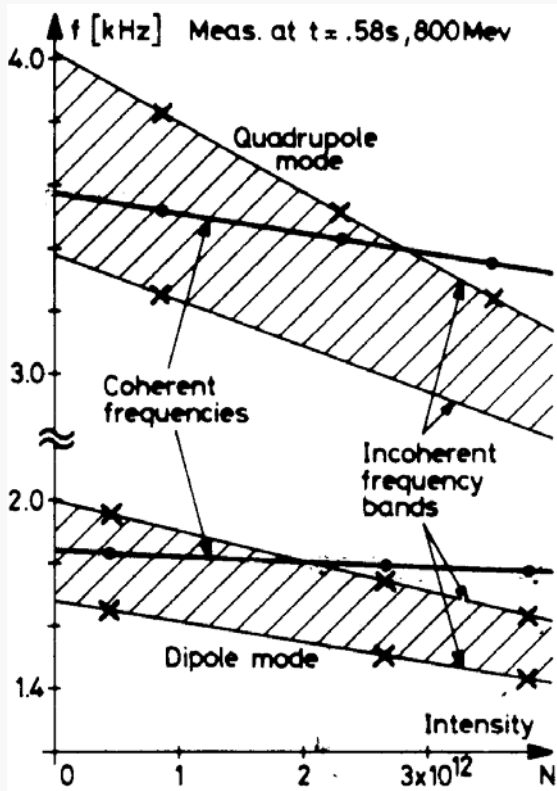
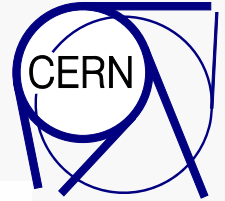

Coherent dipole and quadrupole mode frequencies and incoherent frequency bands from coupled bunch mode BTF (1977, h = 5 only)

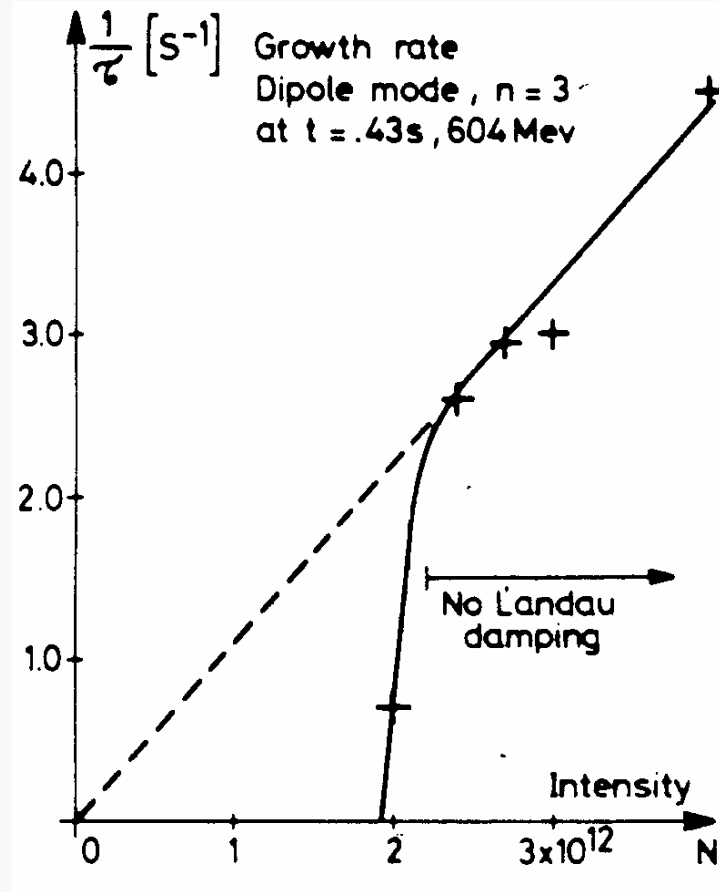

Growth rate of n = 3 dipole mode versus intensity

Coupled Bunch modes



- Was a serious problem from 1973 to 1998 primarily due to the low threshold for loss of Landau damping
 - Space charge impedance cancel Landau damping
 - Small resistive resonators drives coupled bunch modes
 - Magnani shaking (1973, longitudinal blow-up)
 - Active coupled bunch mode system [$n = 1,2,3,4$; $m = 1$ (dipole) ,2 (quadrupole) and 3 (sextupole)] added in all rings in 1976
 - $n = 0$, $m = 2$ quadrupolar ‘Hereward’ damping added in 1977.
- With the conversion to $h = 1$ & 2 in 1998, the coupled bunch mode issue disappeared
 - With the larger longitudinal emittance (0.6 -> 1.2 eVs total), also the need for quadrupolar damping disappeared

Adding Second Harmonic RF



- Transverse Space charge is (or should be?) the main intensity limiting factor in the PSB due to tune spread within bunch
- The intensity limit depends directly on the bunching factor
$$B_f = I_{av}/I_{peak}$$
- B_f can be significantly increased by:
 - flattening the RF potential well (adding second harmonic RF), or
 - modifying the longitudinal phase space distribution (second harmonic debuncher, empty bucket deposit), or
 - both methods combined

Adding Second Harmonic RF

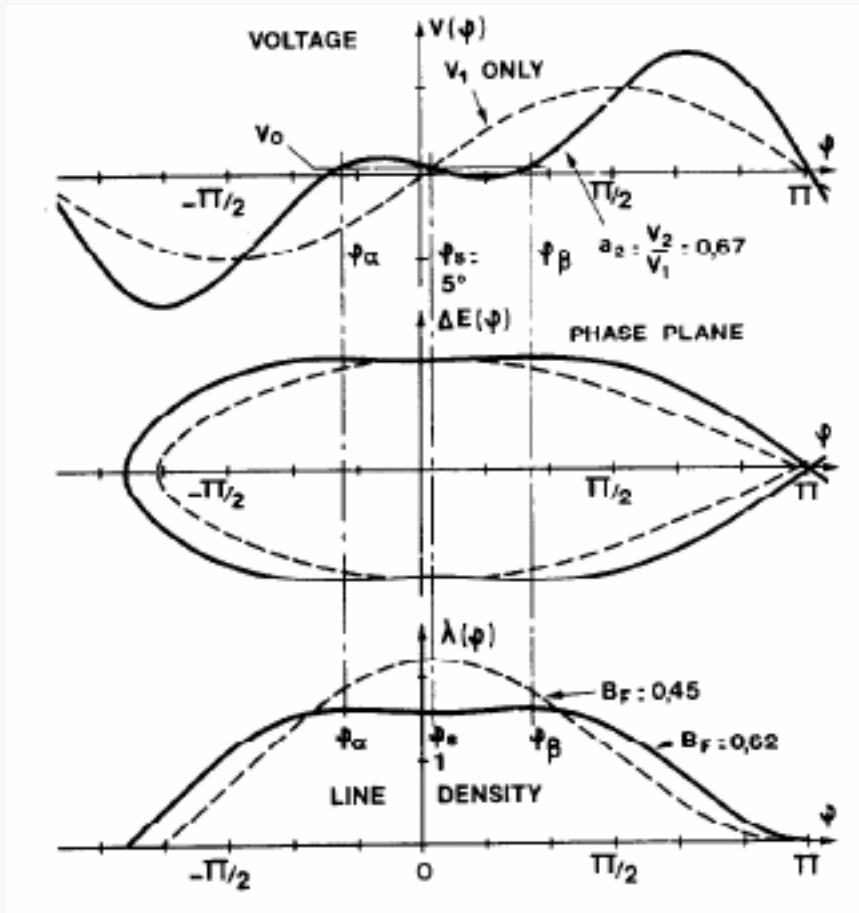
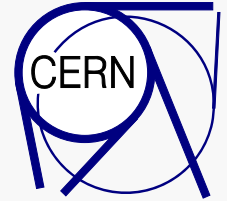

Voltage wave shape

Bucket shape

Line density

Adding Second Harmonic RF

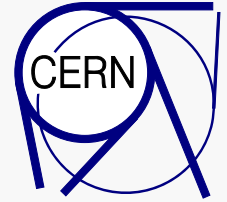

Bunching factor versus second harmonic RF voltage

Stationary and moving bucket

Optimum gain well into dual peak region

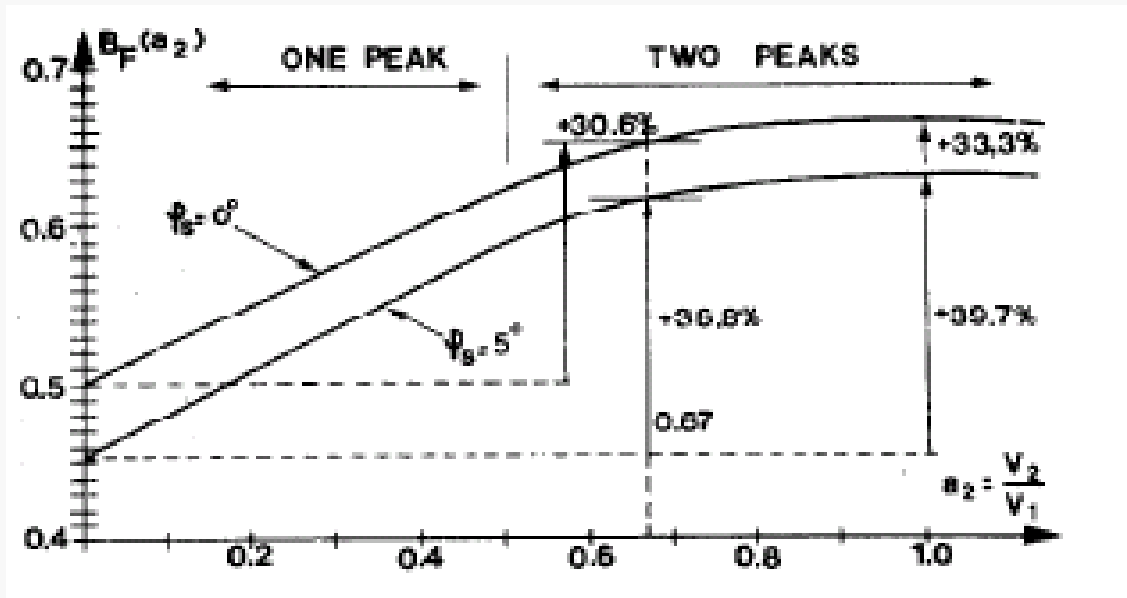

Adding Second Harmonic RF

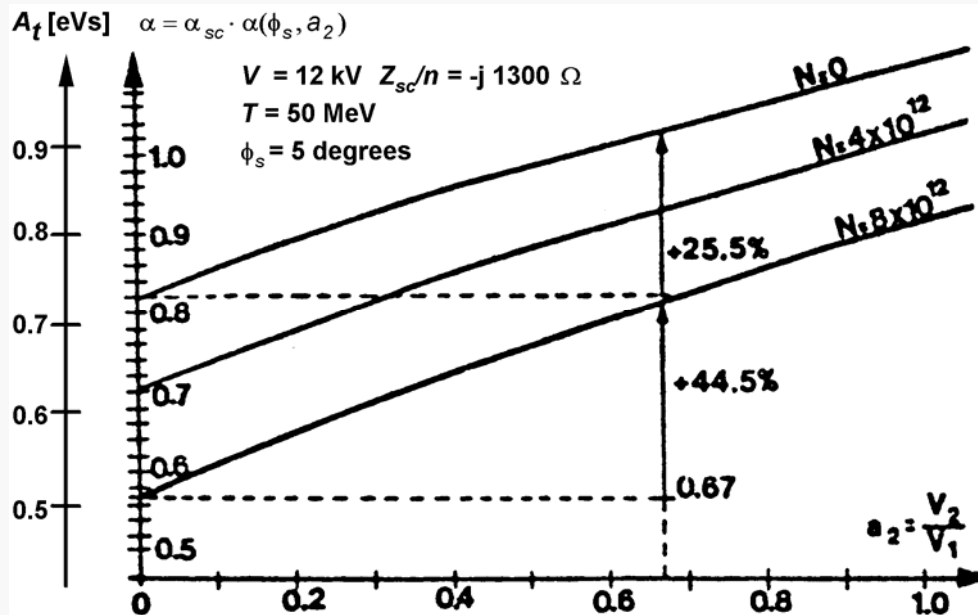
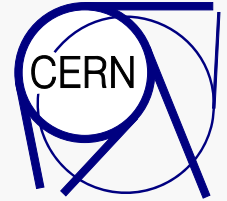

Bucket area (total) versus second harmonic voltage ($h = 5$ & 10) and intensity

Significant increase in bucket area with added second harmonic

The longitudinal space charge limit (bucket area zero) scales as V_{RF}/h so bucket area reduction with space charge 3.3 times less for $h = 1$ & 2 than with $h = 5$ & 10

Adding Second Harmonic RF

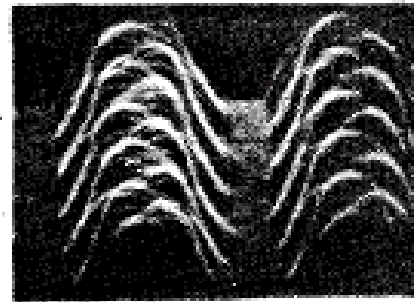
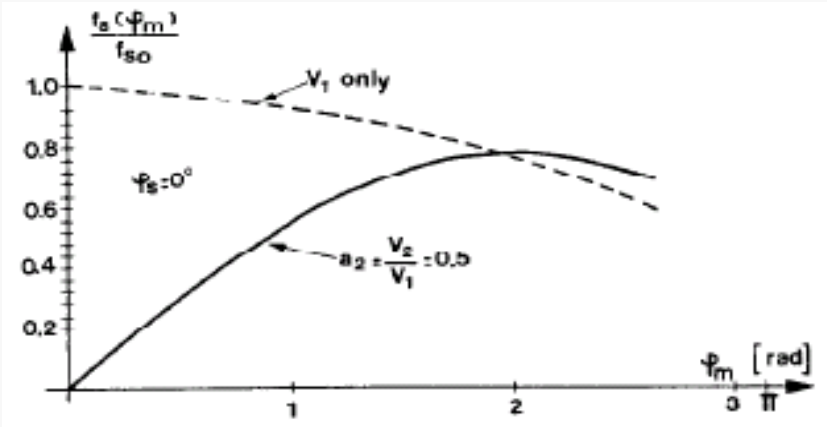
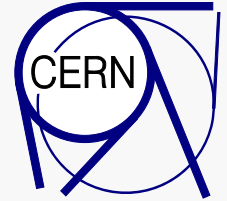

$n = 0 \quad m = 3$



$n = 0 \quad m = 5$

$T_s = 3 \text{ ns}$

- Synchrotron frequency versus amplitude with and without second harmonic RF
- Flat maximum in synchrotron frequency vs. amplitude and phase space density gradient cause loss of Landau damping even without space charge (Shaposhnikova, Koscielniak)
- Instabilities appear due to excessive delays in beam phase loop and second harmonic loop

Adding Second Harmonic RF

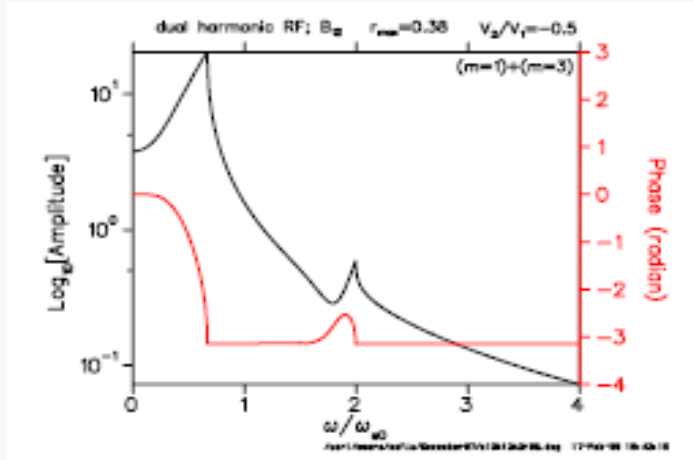
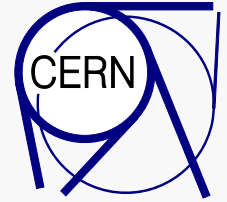

Beam transfer function, small emittance, from second harmonic RF phase to beam fundamental phase (Koscielniak)

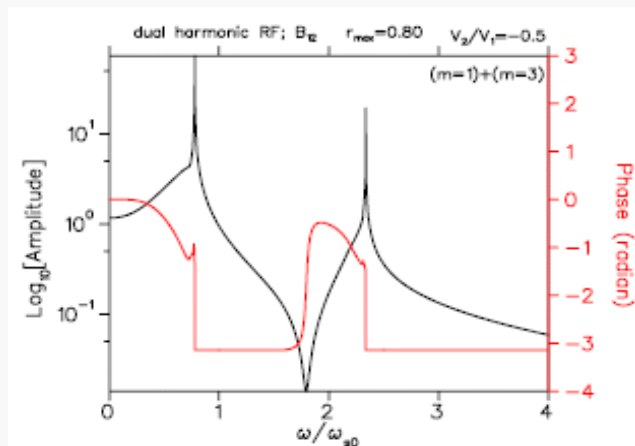

Beam transfer function, large emittance (populated beyond critical amplitude)

Stability improved by servoing second harmonic RF phase relative to beam phase

Stability of Hollow Distributions

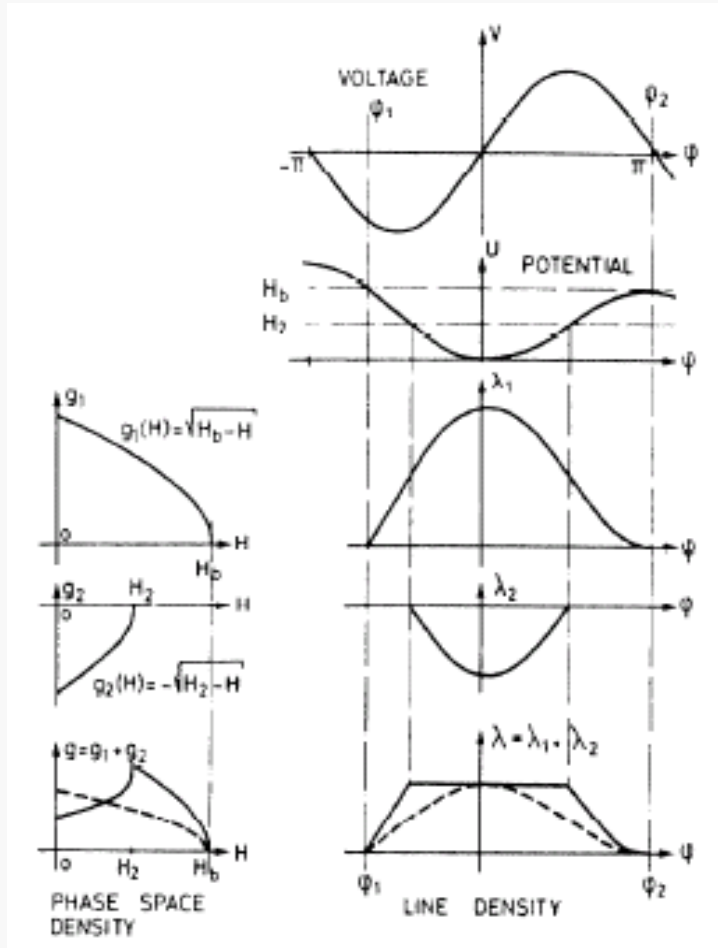
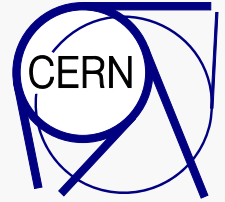

- Flat topped bunched can be designed with a phase space density which is a sum of two elliptic distributions
- Sign change of gradients create 360 degree BTF response (Koscielniak)
- Steep density gradients cause loss of Landau damping
- So what if we soften the gradients?

Stability of Hollow Distributions



- Stability problematic (strong beam phase loop) if the positive slope of the density profile is too steep
- Series of computer simulations and MDs in 1998/99 using empty bucket deposit (C16) at 50 MeV and single and dual harmonic: C02 & C04.
- Never made operational due to stability problems. More effort would be needed

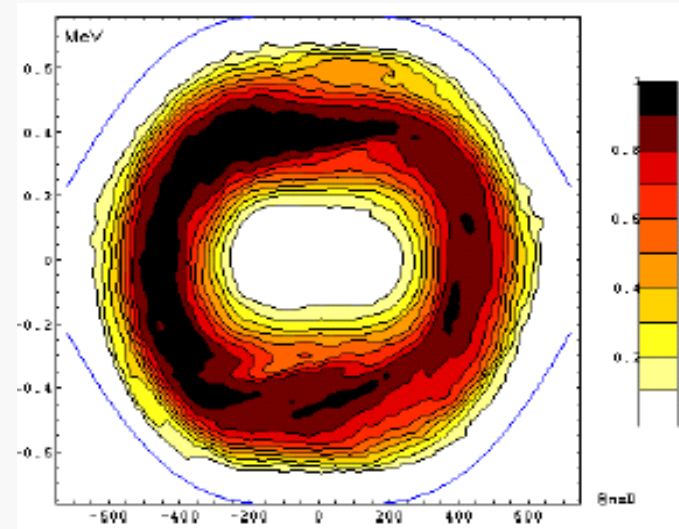
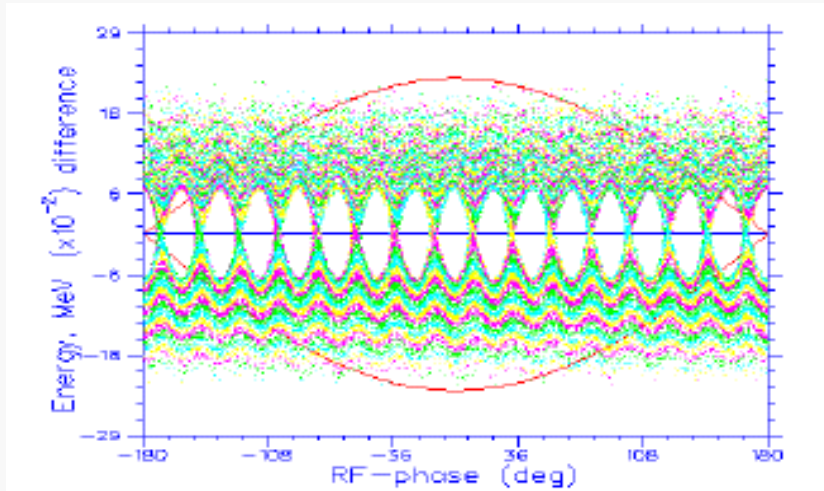

Stability of RF fundamental

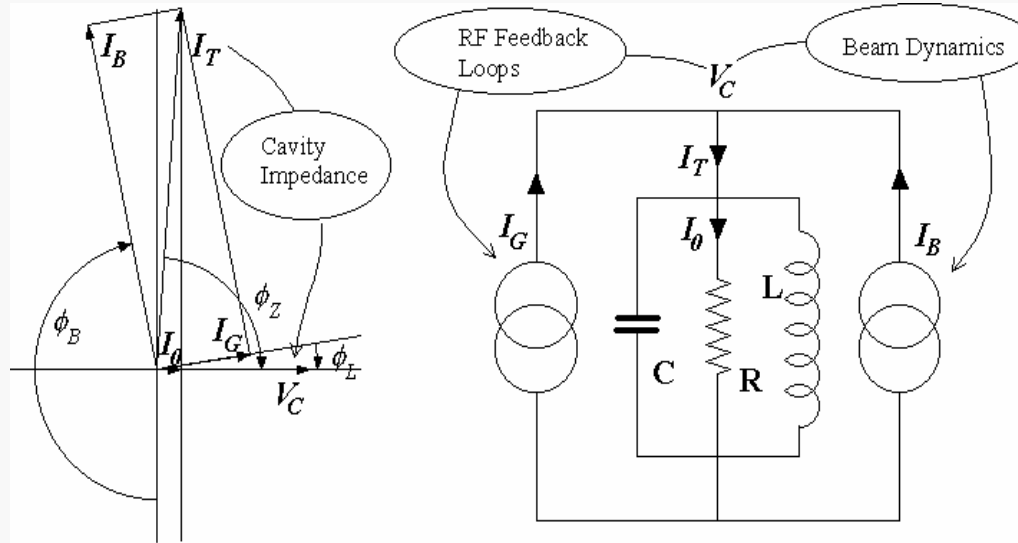

- Linearise propagation of small modulations (phase and amplitude) of main vectors:
- Cavity voltage to beam current: *Beam Dynamics*
- Cavity voltage to generator current: *RF feedback loops*
- Total current (sum of generator and beam currents) to cavity voltage: *Cavity impedance*

Stability of RF fundamental

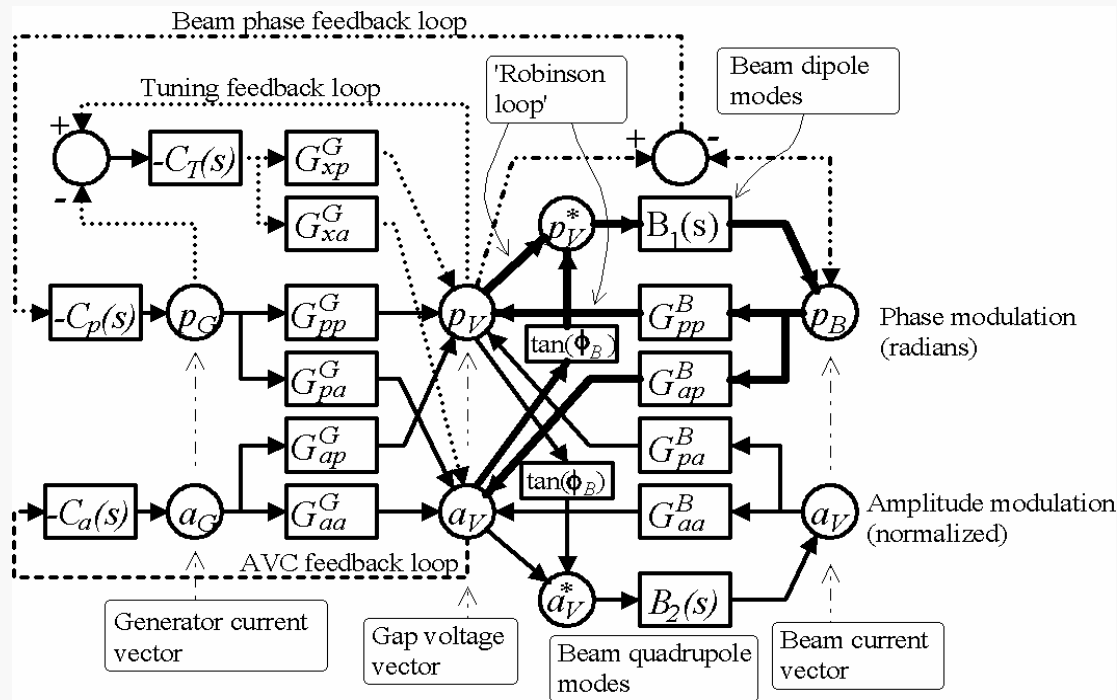

- At high intensity, **vector geometry and detuned cavity** leads to significant **cross coupling between loops**, which cause instability
- With no feedback present, the stability of beam cavity interaction can be solved analytically: **Robinson criterion**

Stability of RF fundamental

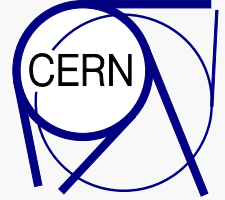

- Robinson criterion does not apply to most proton synchrotrons as many fairly fast feedback loops modify the dynamics of the system
- Around $I_B/I_0 > 2$, the loop cross-couplings makes the system unstable
- Most effective means to lower the apparent I_B/I_0 is direct RF feedback around the RF cavity
- All current RF systems in the PSB (C02, C04, C16) are equipped with strong direct RF feedback loops
- Another important trick is to use an appropriate sensor ('normalised reactive power detector') for the tuning loop feedback to ensure stability under all forward/reverse power flow situations
- Nevertheless, the C04 system can for example not be operated below a few kV at highest intensity.

Microwave Instability



- In the pre-LHC era ($h = 5$ & 10), a microwave instability was observed in R4 with coherent signals around 1 GHz for intensities above 6.5×10^{12} protons per ring
- It was identified as being caused by resonant longitudinal coupling impedances associated with vacuum manifolds: $R_{sh} \sim 40$ k ohms, $R/Q = 25$ ohms and $f = 1100$ MHz
- In the 97/98 shutdown, flexible perforated sleeves have been installed in the manifolds, and the problem has disappeared
- The conversion to $h = 1$ & 2 in 1998 with almost doubled longitudinal acceptance $E_{LT} = 0.7 \rightarrow 1.2$ eVs

Overview of History of PSB RF



- 1973: So-called ‘Magnani’ shaking [4] to combat longitudinal coupled bunch instabilities by longitudinal blow-up shortly after the midpoint of the cycle, where the bucket is no longer full. It allowed the Booster to achieve its design intensity.
- 1976: Coupled bunch feedback system which allowed the PSB to be operated above the space charge Landau damping threshold for dipole and quadrupole modes.
- 1977: Hereward’ type quadrupolar feedback loop to damp the $n = 0, m = 2$ quadrupole mode driven by the C08 RF system.
- 1982: Second harmonic RF systems added (C16, 6 - 16 MHz, 8 kVp, $h = 10$) to improve bunching factor and transverse space charge limit.
- 1985: Two tube operation of C08 system to cope with the high beam loading power.

Overview of History of PSB RF



- 1990: Upgrade of C08 final power amplifiers for direct RF feedback to improve beam loading instabilities.
- 1993: Pre-prototype $h = 1$ cavity installed in ring 3, C08 system in ring 3 modified to operate on $h = 2$ in addition to normal operation on $h = 5$. New standardized (PS & PSB) digital beam control system used to accelerate nominal LHC beam at $h = 1$ & 2 to 1.4 GeV for LHC MD.
- 1994: New controls interface installed and commissioned. Digital beam control commissioned in all four rings for lead ion acceleration on RF harmonics $h = 17, 10$ and 5. Screen grid protection systems installed on the C08 RF systems to reduce tube failure rate.

Overview of History of PSB RF



- 1996: New tuning and AVC low level electronics in C08 systems.
- Prototype C08 cavity capable of operating at $h = 2$ (8 kVp) or $h = 5$ (12 kVp) in ppm and with direct RF feedback in both cases.
- 1997: Prototype C02 $h = 1$ cavity (8 kVp) to be installed in ring 3.
- 1998: C02 ($h = 1$ with 8 kVp) RF systems installed in all rings.
- All C08 systems converted to $h = 2$ operation (C04). The C16 RF systems retained for controlled longitudinal blow-up and control of bunch shapes.

Transverse Instabilities



- Transverse instabilities driven by the resistive wall impedance, occurred early in the history of the PSB.
- Initially cured by moving the tune from below an integer (design) to above an integer. This raises the frequency of the lowest frequency mode and reduces the impedance
- Later, octupoles were needed, but has the adverse effect of exciting resonances due to orbit errors. Compensation of 3rd order resonances are important in the PSB..



- Transverse dampers in both planes for all 4 rings (8 systems) were added in 1981: Switched delay lines for flight time compensation, analog system, bandwidth > 50 MHz. Linear phase Bessel filter reduces bandwidth
- A significant electronic hardware upgrade (solid state power amplifiers, more power, improved low level electronics) was done around 95/96. Bandwidth > 100 MHz. Linear phase Bessel filter reduces bandwidth to 13 MHz
- Currently only the H systems are used. Some of the hardware from the V system has currently been borrowed to complete the LEIR system: problems with components obsolescence.